

## INSTALLATION PROCEDURE (FOR INDOOR USE ONLY)

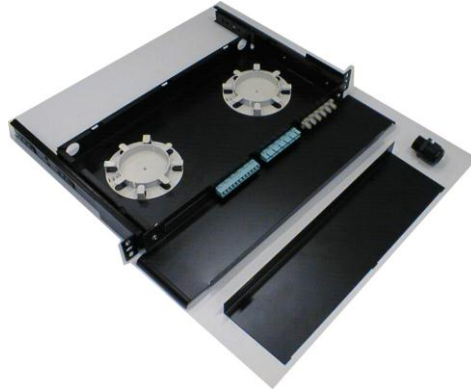
This instruction sheet covers the installation of the 1U S-LIU for indoor use only.

### Shelf Description

The 1U S-LIU is a frame-mounted, pullout shelf that is designed to terminate up to 48 LC or, 24 ST®, or 24 SC adapters. The shelf can also be used as a splice unit to store 32 single fusion splices, or 12 mass fusion splices. The overall dimensions of the shelf are 1.72 inches (44 mm) high, 17.19 inches (437 mm) wide, and 11.20 inches (285 mm) deep.

As illustrated in Figure 1, the shelf contains a sliding tray with two holes in the rear for fittings that provide strain-relieve for incoming nonmetallic Outside Plant (OSP) cable or LightGuide Building (LGBC) cable. Upon entering the tray, the cable is prepared for either direct termination or splicing. Inside the tray, the buffered fibers can be wrapped around one or two 3-inch (76 mm) diameter storage drums before being terminated or spliced. Up to two splice organizers need to be added to the tray if splicing is required. The splice organizers are attached to the tray with double-sided tape (provided with organizer kits).

Also included with the shelf is an integrated front trough and cover to help route and contain fiber jumpers within the frame structure.



#### **Contents:**

- (1) Main Shelf with Integrated Trough
- (1) Strain Relief Grommet
- (1) Trough Cover
- (1) Shelf Cover (Not Shown)
- (4) #12-24 x 3/8-inch Screws
- (1) Label
- (1) Instruction Sheet

**Figure 1. 1U S-LIU1 Shelf**

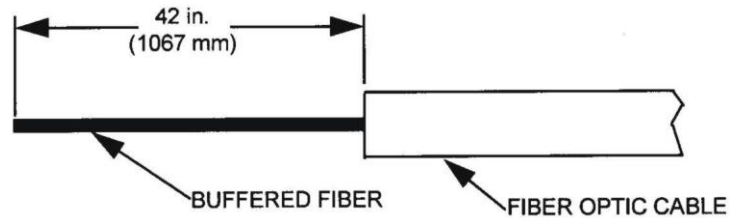
#### **NOTE:**

The mounting brackets included are for a 19-inch frame. A kit of parts is available for mounting in a 23-inch frame (109172197).

Adapters are factory installed dependant upon the ordering code selected. Reference your order for detail of adapters included.

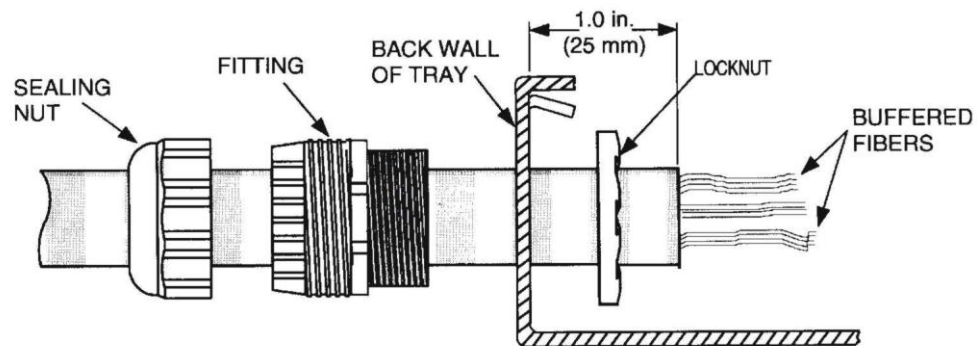
## CABLE INSTALLATION (FOR DIRECT TERMINATION)

---

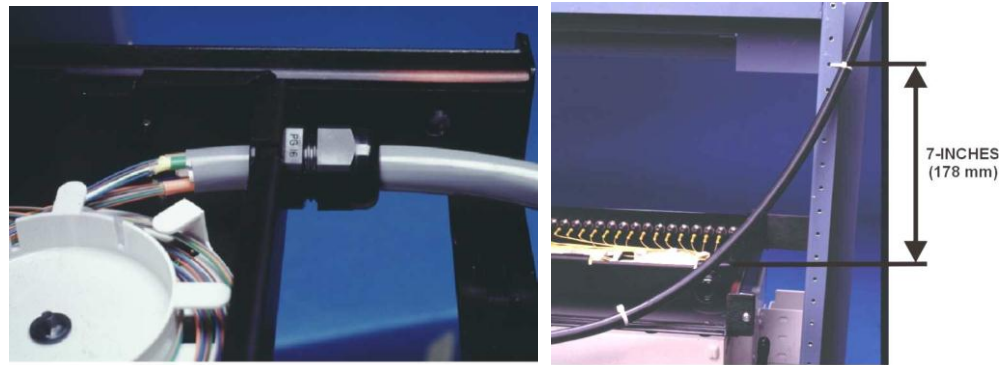


**Figure 2. Preparing Fiber Optic Cables**

1. Prepare the fiber optic cable(s) as shown in 2.
2. Install appropriate connectors on buffered fibers for type of adapters ordered
3. Secure the incoming fiber optic cable(s) to the tray using the strain-relief cable fitting provided (see Figure 3 and Figure 4).
4. Adjust the cable diameter by wrapping the cable strain area with suitable tape as needed to best fit within the fitting.
5. Secure the cable egressing from the rear of the shelf to the frame with cable ties. Ensure proper cable slack remains to allow for sliding action of the shelf.

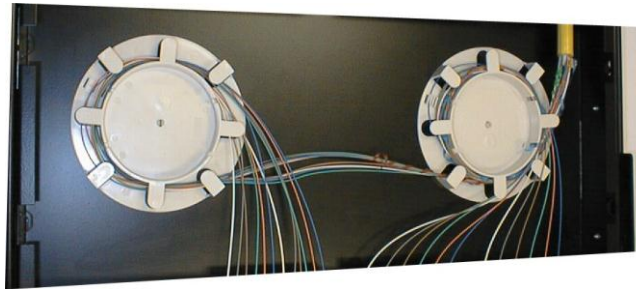


**Figure 3. Securing the Fiber Optic Cable(s)**



**Figure 4. Cable Installation**

6. Route the buffered fibers with connectors around the storage drum(s) to the couplings (see Figure 5).
7. Install the plastic cover plate over the installed fiber to protect and retain the fibers within the shelf.



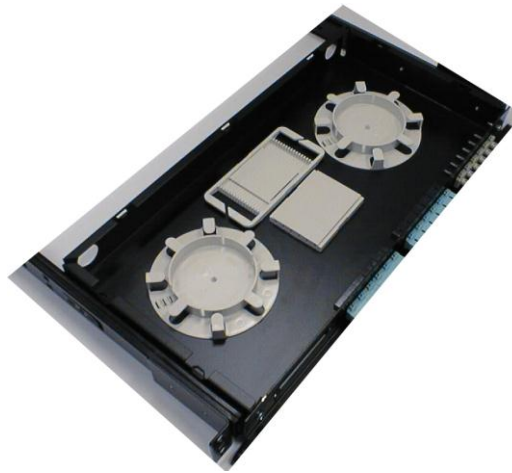
**Figure 5. Routing Buffered Fibers in Tray**

## **CABLE INSTALLATION (FOR SPLICING)**

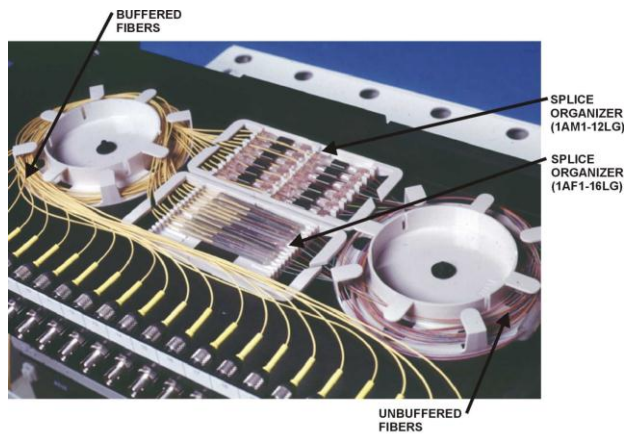
---

1. Install two splice organizers to the tray approximately as shown in Figure 6, if splicing is required. Splice organizers are sold separately.
2. Prepare the fiber optic cable(s) as shown in Figures 2 & 3.
3. Secure the incoming fiber optic cable(s) to the tray using the cable strain-relieve fitting(s) provided (see Figure 4).
4. Organize the fibers to the splice organizers and then perform splicing.
5. Place splices into the splice organizers in recommended sequential order as shown in Figure 7. Position numbers on splice organizers are shown for information only; no numbers appear on the organizers.

6. Dress slack and spare fibers around the storage drum(s) as shown in Figures 5 & 7.



**Figure 6. Installing Splice Organizers (1 Single Fusion and 1 Mass Fusion Organizer Shown)**



**Figure 7. Dressing Fiber Slack**



**Figure 8 Single Fusion Organizer and Mass Fusion Organizer**